

Report Code: 003_GBP_IIT_EQP_S&R_02_Ver 1_Dec 2010

Sewage Treatment in Class I Towns: *Recommendations and Guidelines*

Preface

In exercise of the powers conferred by sub-sections (1) and (3) of Section 3 of the Environment (Protection) Act, 1986 (29 of 1986), the Central Government has constituted National Ganga River Basin Authority (NGRBA) as a planning, financing, monitoring and coordinating authority for strengthening the collective efforts of the Central and State Government for effective abatement of pollution and conservation of the river Ganga. One of the important functions of the NGRBA is to prepare and implement a Ganga River Basin: Environment Management Plan (GRB EMP).

A Consortium of 7 Indian Institute of Technology (IIT) has been given the responsibility of preparing Ganga River Basin: Environment Management Plan (GRB EMP) by the Ministry of Environment and Forests (MoEF), GOI, New Delhi. Memorandum of Agreement (MoA) has been signed between 7 IITs (Bombay, Delhi, Guwahati, Kanpur, Kharagpur, Madras and Roorkee) and MoEF for this purpose on July 6, 2010.

This report is one of the many reports prepared by IITs to describe the strategy, information, methodology, analysis and suggestions and recommendations in developing Ganga River Basin: Environment Management Plan (GRB EMP). The overall Frame Work for documentation of GRB EMP and Indexing of Reports is presented on the inside cover page.

There are two aspects to the development of GRB EMP. Dedicated people spent hours discussing concerns, issues and potential solutions to problems. This dedication leads to the preparation of reports that hope to articulate the outcome of the dialog in a way that is useful. Many people contributed to the preparation of this report directly or indirectly. This report is therefore truly a collective effort that reflects the cooperation of many, particularly those who are members of the IIT Team. Lists of persons who are members of the concerned thematic groups and those who have taken lead in preparing this report are given on the reverse side.

Dr Vinod Tare
Professor and Coordinator
Development of GRB EMP
IIT Kanpur

The Team

1. A A Kazmi, IIT Roorkee	<i>kazmifce@iitr.ernet.in</i>
2. A K Gupta, IIT Kharagpur	<i>akgupta18@rediffmail.com,akgupta@iitkgp.ac.in</i>
3. A K Mittal, IIT Delhi	<i>akmittal@civil.iitd.ernet.in</i>
4. A K Nema, IIT Delhi	<i>aknema@gmail.com</i>
5. Ajay Kalmhad, IIT Guwahati	<i>kajay@iitg.ernet.in</i>
6. Anirban Gupta, BESU Shibpur	<i>guptaanirban@hotmail.com</i>
7. Arun Kumar, IIT Delhi	<i>arunku@civil.iitd.ac.in</i>
8. G J Chakrapani, IIT Roorkee	<i>gjcurfes@iitr.ernet.in</i>
9. Gazala Habib, IIT Delhi	<i>gazalahabib@gmail.com</i>
10. Himanshu Joshi, IIT Roorkee	<i>himanshujoshi58@gmail.com</i>
11. Indu Mehrotra, IIT Roorkee	<i>indumfce@iitr.ernet.in</i>
12. I M Mishra, IIT Roorkee	<i>imishfch@iitr.ernet.in</i>
13. Ligy Philip, IIT Madras	<i>ligy@iitm.ac.in</i>
14. M M Ghangrekar, IIT Kharagpur	<i>ghangrekar@civil.iitkgp.ernet.in</i>
15. Mukesh Doble, IIT Bombay	<i>mukeshd@iitm.ac.in</i>
16. P K Singh, IIT BHU	<i>dr_pksingh1@rediffmail.com</i>
17. Purnendu Bose, IIT Kanpur	<i>pbose@iitk.ac.in</i>
18. R Ravi Krishna, IIT Madras	<i>rrk@iitm.ac.in</i>
19. Rakesh Kumar, NEERI Nagpur	<i>r_kumar@neeri.res.in</i>
20. S M Shivnagendra, IIT Madras	<i>snagendra@iitm.ac.in</i>
21. Saumyen Guha, IIT Kanpur	<i>sguha@iitk.ac.in</i>
22. Shyam R Asolekar, IIT Bombay	<i>asolekar@iitb.ac.in</i>
23. Sudha Goel, IIT Kharagpur	<i>sudhagoel@civil.iitkgp.ernet.in</i>
24. Suparna Mukherjee, IIT Bombay	<i>mitras@iitb.ac.in</i>
25. T R Sreekrishanan, IIT Delhi	<i>sree@dbeb.iitd.ac.in</i>
26. Vinod Tare, IIT Kanpur	<i>vinod@iitk.ac.in</i>
27. Vivek Kumar, IIT Roorkee	<i>vivekfpt@iitr.ernet.in</i>

Lead Persons

1. Vinod Tare, IIT Kanpur
2. Ligy Philip, IIT Madras
3. A A Kazmi, IIT Roorkee
4. Purnendu Bose, IIT Kanpur
5. Arvind K Nema, IIT Delhi
6. Atul Mittal, IIT Delhi
7. Arun Kumar, IIT Delhi
8. Indu Mehrotra, IIT Roorkee
9. Subrata Hait, IIT Kanpur

Contents

S No.		Page No.
1	General	5
2	Selection of Appropriate Sewage Treatment Technology	5
3	Treatment Chain	6
4	Cost of Treatment and Land Requirement	7
5	Decision Matrix	7
6	Sludge Management	13
7	Flow Measurement	13
8	Bioassay Test	13
9	References	16
	Appendix I. Exhibits on Options for Secondary Treatment	17

1. General

Sewage is a major point source of pollution. The target of “Nirmal Dhara” i.e. unpolluted flow can be achieved if discharge of pollutants in the river channel is completely stopped. Also, sewage can be viewed as a source of water that can be used for various beneficial uses including ground water recharge through surface storage of treated water and/or rain/flood water in an unlined reservoir. This may also help achieving “Aviral Dhara”.

In order to reduce substantial expenditure on long distance conveyance of sewage as well as treated water for recycling, decentralized treatment of sewage is advisable. As a good practice, many small sewage treatment plants (STP) should be built rather than a few of very large capacity. All new developments must build in water recycling and zero liquid discharge systems. Fresh water intake should be restricted only to direct human-contact beneficial uses of water. For all other uses properly treated sewage/wastewater should be used wherever sufficient quantity of sewage is available as source water for such purposes. All new community sanitation systems must adopt recycling of treated water for flushing and completely isolate fecal matter until it is converted into safe and usable organic manure. The concept of decentralized treatment systems and water/wastewater management will be covered in detail in subsequent reports.

2. Selection of Appropriate Sewage Treatment Technology

Item 4.5.2 in Guidelines for the Preparation of Urban River Management Plan (URMP) for all Class I Towns in Ganga River Basin (Report No. 002_GBP_IIT_EQP_S&R_01) concerns with sewage treatment plant. One of the most challenging aspects of a sustainable sewage treatment system (either centralized or decentralized) design is the analysis and selection of the treatment processes and technologies capable of meeting the requirements. The process is to be selected based on required quality of treated water. While treatment costs are important, other factors should also be given due consideration. For instance, effluent quality, process complexity, process reliability, environmental issues and land requirements should be evaluated and weighted against cost considerations. Important considerations for selection of sewage treatment processes are given in Table 1.

Table 1: Sewage Treatment Process Selection Considerations

Consideration	Goal
Quality of Treated Sewage	Production of treated water of stipulated quality without interruption
Power requirement	Reduce energy consumption
Land required	Minimize land requirement
Capital Cost of Plant	Optimum utilization of capital
Operation & Maintenance costs	Lower recurring expenditure
Maintenance requirement	Simple and reliable
Operator attention	Easy to understand procedures
Reliability	Consistent delivery of treated sewage
Resource Recovery	Production of quality water and manure
Load Fluctuations	Withstand variations in organic and hydraulic loads

3. Treatment Chain

All sewage treatment plants should follow a process chain depending upon the technology chosen and the treatment capacity. In general, treatment is to be done in three stages as per the flow sheet presented in Figure 1.

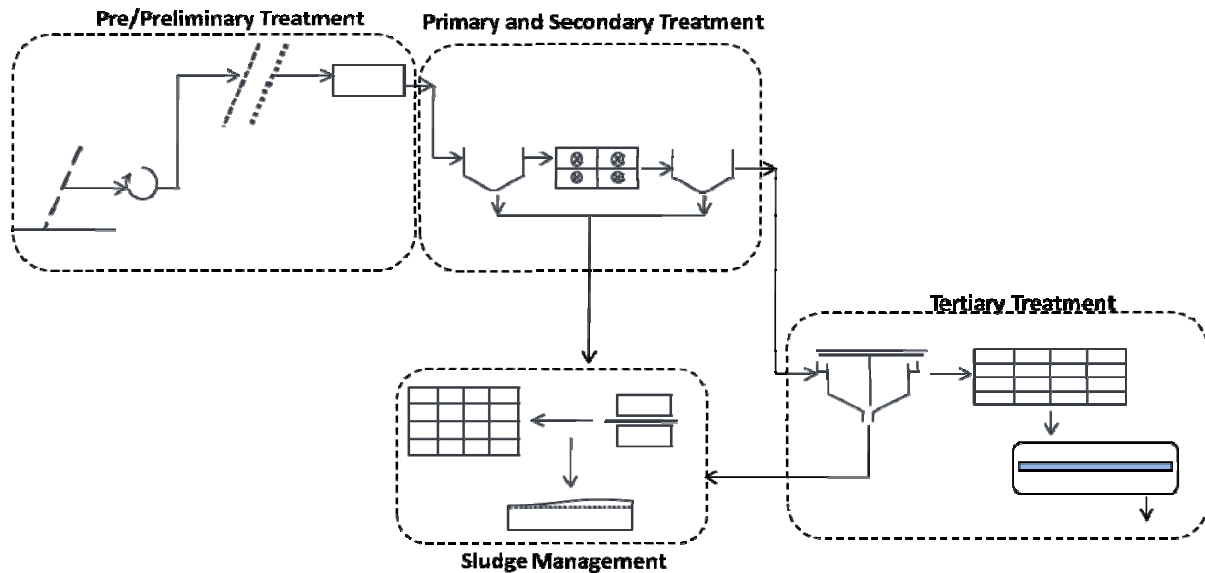

Figure 1: Process Chain for Sewage Treatment

Specifications and treatment objectives at each stage of treatment are as follows.

Stage I Preliminary Treatment:

- Three Stage Screening:
 - 25 mm bar racks (before pumping)
 - 12 mm bar racks
 - 5 mm mesh (< 2 mm mesh for Membrane Bio Reactor, MBR)
- Aerated Grit Chamber if following unit operation is aerobic and Normal Grit Chamber if following unit operation is anaerobic.

Expected effluent quality after preliminary treatment:

- No floating materials including polythene bags, small pouches, etc.
- Proper collection and disposal of screening and grit.

Stage II Primary and/or Secondary Treatment: Many options are available for second stage treatment. These options can be grouped into following three categories.

- Pond Based Systems or
- Activated Sludge Process (ASP) and its Modifications or equivalent systems including but not limited to SBR, UASB followed by ASP, ASP operated on Extended Aeration mode (EA-ASP), ASP with Biological Nutrient Removal (ASP+BNR), and MBBR or
- Membrane Bio Reactor (MBR)

Expected effluent quality after primary and secondary treatment:

- BOD < 30 mg/L
- SS < 20 mg/L
- Nitrified effluent

A brief description of various technological options available for secondary treatment are presented in Appendix I. EA-ASP, ASP+BNR are considered to be variations of ASP and produce more or less same quality effluent (particularly when tertiary treatment is adopted after secondary treatment) and have approximately same treatment plant footprint. The treatment cost is also of the same order and hence are not considered to be distinctly different than ASP.

Stage III Tertiary Treatment: Coagulation-flocculation-settling followed by filtration and disinfection is generally recommended. Other processes could be selected on the basis of land availability, cost considerations, O&M cost, reuse option, compatibility issues in case of up-gradation of existing plants, etc. However, disinfection operation should invariable be included. Expected effluent quality after tertiary treatment:

- BOD < 10 mg/L
- SS < 5 mg/L
- Phosphate < 0.5 mg/L
- MPN of fecal coliforms < 10/ 100 mL

Where sewage flows are low and/or land can be spared without compromising on other developmental objectives or agriculture, waste stabilization ponds followed by constructed wetland can be adopted without coagulation-flocculation-settling.

4. Cost of Treatment and Land Requirement

Comprehensive analysis of capital cost, operation and maintenance costs, reinvestment cost, energy cost and land requirement based on data obtained from various STPs in the Ganga river basin and elsewhere in India has been done. This analysis has been summarized in Figure 2 as linkage between the treatment cost (₹/KL as in 2010) and the required footprint of the treatment plant (m²/MLD) for various suggested technological options. For a particular desired effluent quality, the technological option with higher treatment cost will generally require lower treatment plant footprint, and vice versa.

5. Decision Matrix

The selection of a process requires analysis of all factors, not just treatment costs. In order to provide additional factors for the final considerations, key parameters need to be evaluated and weighed as shown in the Exhibit 1 to reach a final recommendation. The matrix attributes are ranked as Low, Medium, High and Very High recognizing that differences between processes are relative, and often, the result of commonly accepted observations. The column entitled "Typical Capacity Range" is added to illustrate the range in which the treatment plants based on specific processes have been built so far in the

country should not be construed as showing technological limitations, nor to affirm that plants outside that range do not exist. The ranges simply indicate most frequently found sizes. A comparison of treatment costs and evaluation of various technologies for sewage treatment in India is presented in Table 2.

In general it is accepted worldwide that the technologies which are deemed to be appropriate have to be qualified through application of a rigorous framework underscoring the performance expectations as well as the choice should be concurrent with the socio-economic acceptability.

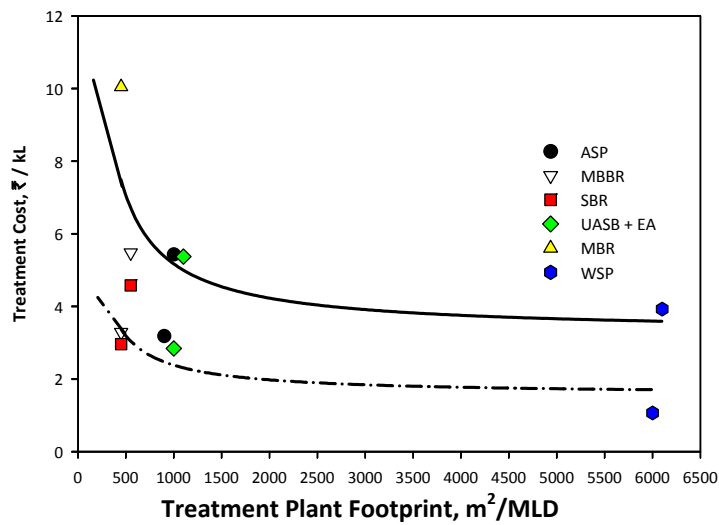
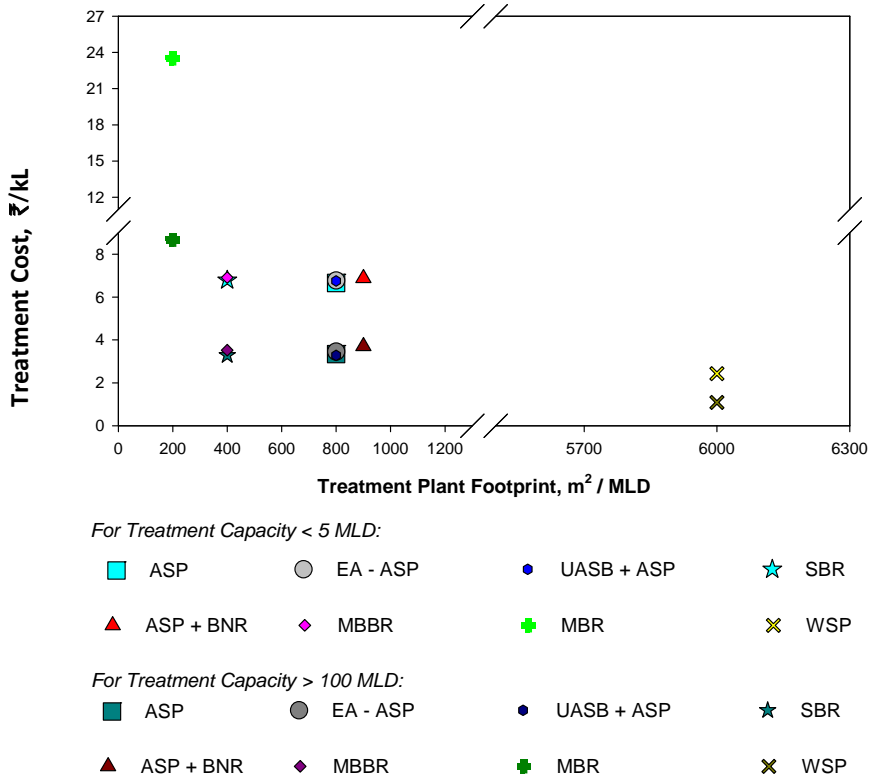

Figure 2: Treatment Cost (as in 2010) and Corresponding Plant Footprint for various Secondary Treatment Options

Table 2: Comparison of Treatment Costs of Various Technologies for Sewage Treatment in India

S. No.	Assessment Parameter/Technology	ASP ^{*a}	MBBR ^{*c}	SBR ^{*a}	UASB+EA ^{*b}	MBR ^{*a}	WSP ^{**b}
1.0	Performance after Secondary Treatment						
1.1	Effluent BOD, mg/L	<20	<30	<10	<20	<5	<40
1.2	Effluent SS, mg/L	<30	<30	<10	<30	<5	<100
1.3	Faecal coliform removal, log unit	upto 2<3	upto 2<3	upto 3<4	upto 2<3	upto 5<6	upto 2<3
1.4	T-N Removal Efficiency, %	10-20	10-20	70-80	10-20	70-80	10-20
2.0	Performance After Tertiary Treatment						
2.1	Effluent BOD, mg/L	<10	<10	<10	<10	<10	<10
2.2	Effluent SS, mg/L	<5	<5	<5	<5	<5	<5
2.3	Effluent NH ₃ N, mg/L	<1	<1	<1	<1	<1	<1
2.4	Effluent TP, mg/L	<0.5	<0.5	<0.5	<0.5	<0.5	<0.5
2.5	Effluent Total Coliforms, MPN/100 mL	10	10	10	10	10	10
3.0	Capital cost						
3.1	Average Capital Cost (Secondary Treatment), ₹. Lacs/MLD	68.00	68.00	75.00	68.00	300.00	23.00
3.2	Average Capital Cost (Tertiary Treatment), ₹. Lacs/MLD	40.00	40.00	40.00	40.00		40.00
3.3	Total Capital Cost (Secondary + Tertiary) ₹. Lacs/MLD	108.00	108.00	115.00	108.00	300.00	63.00
3.4	Civil Works, % of total capital costs	60.00	40.00	30.00	65.00	20.00	90.00
3.5	E & M Works, % of total capital costs	40.00	60.00	70.00	35.00	80.00	10.00
4.0	Area Requirements						
4.1	Average Area, m ² per MLD Secondary Treatment + Secondary Sludge Handling	900.00	450.00	450.00	1000.00	450.00	6000.00
4.2	Average Area, m ² per MLD Tertiary Treatment + Tertiary Sludge Handling	100.00	100.00	100.00	100.00	0.00	100.00
4.3	Total Area, m ² per MLD Secondary + Tertiary Treatment	1000.00	550.00	550.00	1100.00	450.00	6100.00

Sludge Treatment: * Thickener + Centrifuge; ** Drying
 Process Type : ^a Aerobic; ^b Anaerobic-Aerobic; ^c Anoxic/Anaerobic-Aerobic

S. No.	Assessment Parameter/Technology	ASP ^{*,a}	MBBR ^{*,c}	SBR ^{*,a}	UASB+ASP ^{*,b}	MBR ^{*,a}	WSP ^{**,b}
5.0	Operation & Maintenance Costs						
5.1	Energy Costs (Per MLD)						
5.1.1	Avg. Technology Power Requirement, kWh/d/MLD <i>Secondary Treatment + Secondary Sludge Handling</i>	180.00	220.00	150.00	120.00	300.00	2.00
5.1.2	Avg. Technology Power Requirement, kWh/d/MLD <i>Tertiary Treatment + Tertiary Sludge Handling</i>	1.00	1.00	1.00	1.00	1.00	1.00
5.1.3	Avg. Non-Technology Power Req., kWh/d/MLD <i>Secondary Treatment</i>	4.50	2.50	2.50	4.50	2.50	2.50
5.1.4	Avg. Non-Technology Power Req., kWh/d /MLD <i>Tertiary Treatment</i>	0.20	0.20	0.20	0.20		0.20
5.1.5	Total Daily Power Requirement (avg.), kWh/d /MLD	185.70	223.70	153.70	125.70	302.50	5.70
5.1.6	Daily Power Cost (@₹ 6.0 per KWh), ₹ /MLD/h <i>(Including Standby power cost)</i>	46.43	55.93	38.43	31.43	75.93	1.43
5.1.7	Yearly Power Cost, ₹. lacs pa/MLD	4.07	4.90	3.37	2.75	6.65	0.49
5.2	Repairs cost (Per MLD)						
5.2.1	Civil Works per Annum, as % of Civil Works Cost	3.00	3.00	3.00	3.00		3.00
5.2.2	E&M Works, as % of E&M Works Cost	1.00	1.00	1.00	1.00		1.00
5.2.3	Civil Works Maintenance, ₹. Lacs pa /MLD	1.94	1.30	1.04	2.11		1.70
5.2.4	E & M Works Maintenance, ₹. Lacs pa/MLD	0.43	0.65	0.81	0.38		0.06
5.2.5	Annual repairs costs, ₹. Lacs pa/MLD	2.38	1.94	1.84	2.48		1.76
5.3	Chemical Cost (Per MLD)						
5.3.1	Recurring Chemical/Polymer Costs, ₹. Lacs pa/MLD <i>Secondary Treatment</i>	0.40	0.40	0.40	0.40		0.00
5.3.2	Recurring Chemical, ₹. Lacs pa/MLD <i>(Alum, Chlorine, Polymer) Costs, Tertiary Treatment</i>	4.00	4.00	2.00	5.00		6.00
5.3.3	Other Chemical Cost, ₹. Lacs pa/MLD	0.90	0.90	0.90	0.90		1.20
5.3.4	Total Chemical Cost, ₹. Lacs pa/MLD	5.30	5.30	3.30	6.30		7.20
5.4	Manpower Cost (Assuming 50 MLD Plant)						
5.4.1	Manager, ₹. pa (1 No.)	3.60	3.60	3.60	3.60		3.60
5.4.2	Chemist/Engineer, ₹. pa (1 No.)	3.60	3.60	3.60	3.60		3.60
5.4.3	Operators, ₹. Pa (@₹. 12000 pm)	8.64	5.76	4.32	8.64		4.32
5.4.4	Skilled technicians, ₹. pa (@₹. 10000 pm)	7.20	4.80	3.60	7.20		1.20
5.4.5	Unskilled personnel, ₹. pa (@₹. 7000 pm)	5.04	2.88	2.16	5.04		8.64
5.4.6	Total Salary Costs, ₹. Lacs pa	28.08	20.64	17.28	28.08		21.36
5.4.7	Benefits (50% of total salary), ₹. Lacs pa	14.04	10.32	8.64	14.04		10.68
5.4.8	Salary + Benefits, ₹. Lacs pa	42.12	30.96	25.92	42.12		32.04
5.4.9	Total annual O&M costs, ₹. Lacs pa	629.26	638.11	451.22	618.96	832.55	504.86

S. No.	Assessment Parameter/Technology	ASP ^{*a}	MBBR ^{*c}	SBR ^{*a}	UASB+EA ^{*b}	MBR ^{*a}	WSP ^{**b}
6.0	NPV (2010) of Capital + O&M Cost for 15 years, ₹. Lacs	14838.92	14971.67	12518.32	14684.42	27488.27	10722.96
	Present (2010) Treatment Cost, paisa/L	0.54	0.55	0.46	0.54	1.00	0.39
7.0	Average Capital Cost, ₹. Lacs/MLD <i>upto Secondary Treatment</i>	68.00	68.00	75.00	68.00		23.00
7.1	Yearly Power Cost, ₹. lacs pa/MLD <i>upto Secondary Treatment</i>	4.04	4.87	3.34	2.73		0.10
7.2	Annual Repairs Cost, ₹. Lacs pa/MLD <i>upto Secondary Treatment</i>	1.50	1.22	1.16	1.56		1.11
7.3	Annual Chemical Cost, ₹ Lacs pa/MLD <i>upto Secondary Treatment</i>	0.85	0.85	0.85	0.85		0.60
7.4	Manpower Cost, ₹. Lacs pa <i>for 50 mld plant upto secondary treatment</i>	33.70	24.77	20.74	33.70		25.63
7.5	Total Annual O&M Costs, ₹. Lacs pa <i>upto Secondary Treatment</i>	353.02	372.11	288.15	290.72		116.09
7.6	NPV (2010) of Capital + O&M Cost for 15 years, ₹. Lacs <i>upto Secondary Treatment</i>	8695.35	8981.58	8072.24	7760.85		2891.39
7.7	Present (2010) Treatment Cost, paisa / L <i>upto Secondary Treatment</i>	0.32	0.33	0.29	0.28		0.11

Sludge Treatment: * Thickener + Centrifuge; ** Drying

Process Type : ^a Aerobic; ^b Anaerobic-Aerobic; ^c Anoxic/Anaerobic-Aerobic

- No Sludge Drying Beds. However can be provided to cater 25 % of sludge dewatering under emergency conditions
- No FPU after UASB, only Extended Aeration (EA Process)
- UASB not Recommended for influent SO₄ > 25 mg/L
- No Biological Phosphorus Removal, Coagulants are necessary
- No Energy Recovery system recommended only if BOD < 250 mg/L
- Less than 5h HRT MBBR is not acceptable
- Less than 14 h HRT SBR is not acceptable for plants with peak factor 2.5
- Repair + Chemical + Manpower Cost of MBR is ₹. 500 Lac per 50 MLD
- O&M of MBR includes all chemical (Cleaning, Polymer etc.,) cost
- Capital cost of MBR includes membrane replacement cost for 15 years
- All WSP,s should have mechanical pretreatment works (All types of screens & Grit chambers)
- SBR data is based on data collected from working Indian SBR with bio selector, OUR control, RAS, Nitrogen removal
- Manpower cost is assumed to be 20 percent less for treatment only upto secondary stage

ASP : Activated Sludge Process

UASB : Upflow Anaerobic Sludge Blanket

WSP : Waste Stabilization Pond

MBBR : Moving Bed Biological Reactor

EA : Extended Aeration

SBR : Sequential Batch Reactor

MBR : Membrane Bio Reactor

Exhibit 1: Assessment of Technology Options for Sewage Treatment in the Ganga River Basin

Criteria	ASP	UASB+ASP	SBR	MBBR	MBR	WSP
Performance in Terms of Quality of Treated Sewage						
Potential of Meeting the RAPs TSS, BOD, and COD Discharge Standards	High	High	High	High	High	Medium
Potential of Total / Faecal Coliform Removal	High	High	High	High	High	Low
Potential of DO in Effluent	High	High	High	High	High	High
Potential for Low Initial/Immediate Oxygen Demand	High	High	High	High	High	High
Potential for Nitrogen Removal (Nitrification-Denitrification)	Low	Low	High	Medium	Medium	Low
Potential for Phosphorous Removal	Low	Low	High	Medium	Medium	Low
Performance Reliability						
Impact of Effluent Discharge						
Potential of No Adverse Impact on Land	Medium	Medium	High	High	High	High
Potential of No Adverse Impact on Surface Waters	High	High	High	High	High	High
Potential of No Adverse Impact on Ground Waters	High	High	High	High	High	Medium
Potential for Economically Viable Resource Generation						
Manure / Soil Conditioner	Medium	Medium	Medium	Medium	Low	Low
Fuel	High	Medium	Low	Low	Low	Low
Economically Viable Electricity Generation/Energy Recovery	High	High	Low	Low	Low	Low
Food	Medium	Low	Low	Low	Low	Low
Impact of STP						
Potential of No Adverse Impacts on Health of STP Staff/Locals	Medium	Low	High	High	High	Medium
Potential of No Adverse Impacts on Surrounding Building/Properties	High	Medium	High	High	High	High
Potential of Low Energy Requirement						
Potential of Low Land Requirement						
Potential of Low Capital Cost						
Potential of Low Recurring Cost						
Potential of Low Reinvestment Cost						
Potential of Low Level of Skill in Operation						
Potential of Low Level of Skill in Maintenance						
Track Record						
Typical Capacity Range, MLD	All Flows	All Flows	All Flows	Smaller	Smaller	All Flows



ASP : Activated Sludge Process

UASB : Upflow Anaerobic Sludge Blanket

WSP : Waste Stabilization Pond

MBBR : Moving Bed Biological Reactor

EA : Extended Aeration

SBR : Sequential Batch Reactor

MBR : Membrane Bio Reactor

6. Sludge Management

The sludge dewatering should be done using thickener followed by filter press or centrifuge or any other equivalent mechanical device. Sludge drying beds (SDB) should be provided for emergency only. SDBs should be designed only for 25% of the sludge generated from primary and secondary processes. The compressed sludge should be converted into good quality manure using composting and/or vermi-composting processes. Energy generation through anaerobic digestion of sludges in the form of biogas and subsequent conversion to electrical energy as of now is viable only when sewage BOD > 250 mg/L. Single fuel engines should be used for conversion of biogas to electrical energy. Hazardous sludge, if any should be disposed of as per the prevailing regulations.

7. Flow Measurement

Flow measuring devices should be installed after the Stage I Treatment as well as at the outlet of the sewage treatment plant. These flow devices should be of properly calibrated V notch with arrangements for automatic measurement of head. Additional electronic or other type of flow meters may also be installed. Arrangements should be made for real time display of measured (both current and monthly cumulative) flows at prominent places.

8. Bioassay Test

The bioassay test is gaining importance in wastewater treatment plant design and operation as the whole effluent toxicity (WET) test. This test uses a standard species of aquatic life forms (like fish, algae) as a surrogate to measure the effect of the effluent on the receiving stream. The flow-through method employing continuous sampling is recommended for on-site tests.

- **Flow rate (retention time):** For a flow-through system, the USEPA Manual for Acute Toxicity Test of Effluents (USEPA, 2002) specifies that the flow rate through the proportional dilutor must provide for a minimum of five 90% replacements of water volume in each test chamber every 24 h (i.e. a retention time of 4.8 h) (see Figure 3). This replacement rate should provide sufficient flow to maintain an adequate concentration of dissolved oxygen (DO). This implies a maximum HRT of 5.3 h (i.e. $0.9V/Q = 4.8$) for a flow-through system. Therefore, a flow-through pond with a maximum HRT of 5 h for 100% exposure is recommended for bioassay test of tertiary-treated effluent.
- **Total flow requirement:** 10% of the flow (subjected to maximum 1 MLD) is required to pass through the bioassay pond.

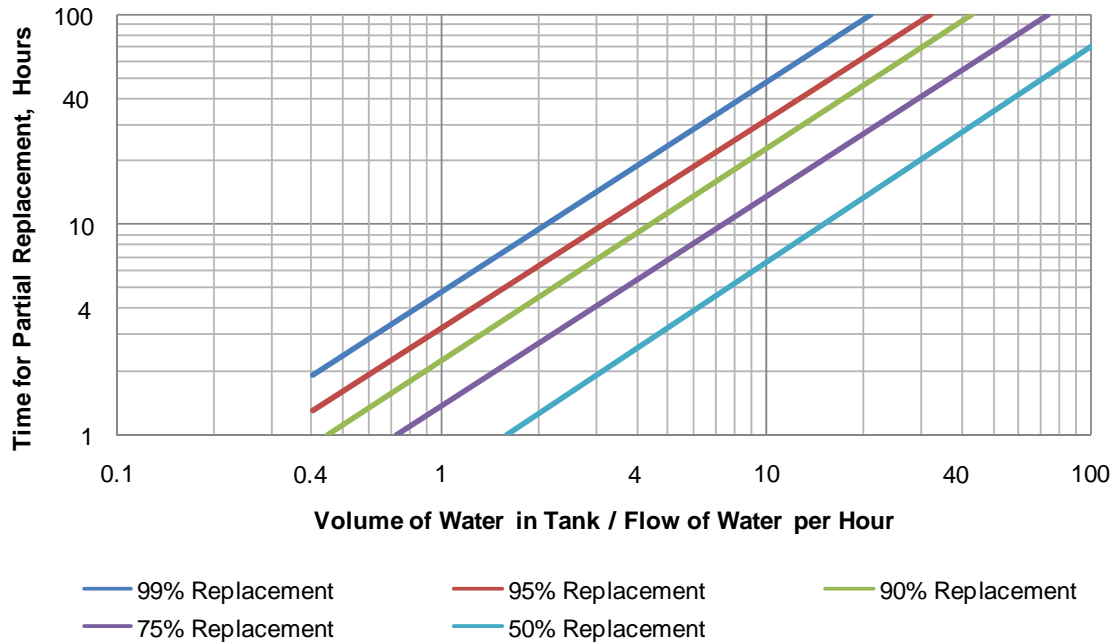

Figure 3: Approximate times required to replace water in test chambers in flow-through tests (For Example: For a chamber containing 4 L, with a flow of 2 L/h, the above graph indicates that 90% of the water would be replaced every 4.8 h. The same time period, such as hours, must be used on both axes, and the same unit of volume, such as liters, must be used for both volume and flow (Adapted from USEPA, 2002))

- **Depth of flow-through system or pond:** The depth of the flow-through bioassay pond should be within 1.5 to 2.5 m based on an equivalent system of wastewater-fed fish pond (aquaculture) (Costa-Pierce, 1998; Hoan and Edwards, 2005).
- **Test organisms:** In the bioassay pond, locally found fish, algae and daphnia should be inhabited in the bioassay pond. USEPA (2002) and APHA *et al.* (1995) have recommended following freshwater fish species when fish is the preferred form of aquatic life/test organism:
 1. *Oncorhynchus mykiss* (rainbow trout) and *Salvelinus fontinalis* (brook trout)
 2. *Pimephales promelas* (fathead minnow)
 3. *Lepomis macrochirus* (Bluegill sunfish)
 4. *Ictalurus punctatus* (Channel catfish)

Based on above, following equivalent fish species are recommended under Indian conditions.

1. *Puntias stigma*
2. *Puntias sophore*
3. *Anabas*
4. *Chela bacalia*
5. *Puntias ticto* and
6. *Colisa faciatus*

Other freshwater fish species like *Gambusia affinis* (mosquito fish) can also be considered. *Daphnia pulex* and *D. magna* (daphnids), *Selenastrum sp.*, *Scenedesmus aculeala*, *Scenedesmus guadacanda* are also recommended similar to the recommendations made by USEPA (2002) for bioassay test.

- **Stocking density and number of test organisms:** For flow-through tests, the live weight of test organisms in the system must not exceed 7.0 g/L (i.e. 7.0 kg/m³) of volume at 15°C, or 2.5 g/L (i.e. 2.5 kg/m³) at 25°C (USEPA, 2002). A minimum of 20 organisms of a given species are required for the test.
- **Feeding requirement:** Considering the bioassay of tertiary-treated sewage effluent and fish as the preferred form of aquatic life/test organism, 32% protein feed at 1% of the stocking biomass/d in two daily slots (preferably morning and evening) with a floating system need to be fed (Costa-Pierce, 1998). The feeding regime for fish mentioned in USEPA (2002) can also be adopted.
- **Aeration and oxygen requirements:** Sufficient DO (4.0 mg/L for warm water species and 6.0 mg/L for cold water species) should be maintained in the pond for proper environment for test organisms. The DO depletion is not a problem in case of a flow-through system because aeration occurs as the water pass through the system. If DO decreases to a level that would be a source of additional stress, the turnover rate of the water volume must be increased (i.e. the HRT of the system must be decreased) sufficiently to maintain acceptable DO levels (USEPA, 2002). Alternatively fountain or cascade aeration arrangements may be provided.
- **Requirement of Dechlorination:** Dechlorinated effluent only should be passed through the bioassay pond. If the effluent from the STP is chlorinated, the total residual chlorine in the effluent should be non-detectable after dechlorination.
- **Bioassay test acceptability criterion:** No mortality (100% survival) of test organisms under any condition.

Salient Features of Recommended STPs

- Continuous measurement of flow at the inlet and outlet
- Excellent preliminary treatment
- Treatment up to tertiary level
- Online bioassay test
- Designed and built as modular units
- Pumping and STPs to be taken together for contracting/bidding

9. References

- APHA, AWWA, WEF (1995) Standard Methods for the Examination of Water and Wastewater, 19th ed. American Public Health Association, American Water Works Association, Water Environment Federation, Washington, DC.
- Arceivala, S. J. and Asolekar, S. R. (2006) Wastewater Treatment for Pollution Control (3rd Edition), McGraw Hill Education (India) Pvt. Ltd., New Delhi
- Asolekar, S. R. and Gopichandran, R. (2005) Preventive Environmental Management – An Indian Perspective”, Foundation Books Pvt. Ltd., New Delhi (the Indian associate of Cambridge University Press, UK)
- Costa-Pierce, B.A. (1998) Preliminary investigation of an integrated aquaculture - wetland ecosystem using tertiary-treated municipal wastewater in Los Angeles County, California. *Ecol. Eng.* 10, 341–354.
- Hoan, V.Q., Edwards, P. (2005) Wastewater reuse through urban aquaculture in Hanoi, Vietnam: Status and prospects, in: Costa-Pierce, B.A., Desbonnet, A., Edwards, P. (Eds.), *Urban Aquaculture*, CABI Publishing, Wallingford, UK, pp. 103–117.
- Kumar, R. (2010) Draft Unpublished Report entitled: Status of Sewage Wastewater and Technology Review In India, NEERI Zonal Office, Mumbai
- Tare, V. and Bose, P. (2009) Compendium of Sewage Treatment Technologies, National River Conservation Directorate, Ministry of Environmental and Forests, Government of India
- USEPA (2002) Methods for Measuring the Acute Toxicity of Effluents and Receiving Waters to Freshwater and Marine Organisms. Fifth ed. EPA-821-R-02-012. Washington DC, U.S.A.

Appendix I: Exhibits on Options for Secondary Treatment

Exhibit 1: ASP - Conventional Activated Sludge Process

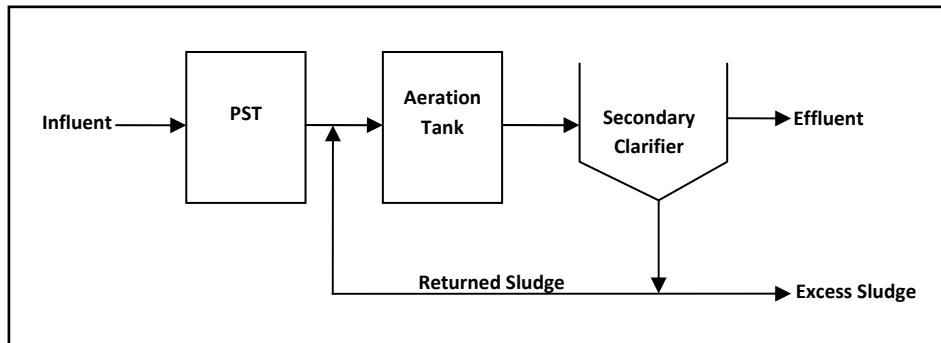

Schematic Diagram of a Conventional Activated Sludge Process

Activated Sludge Process (ASP) is a suspended growth aerobic process. It is provided with primary clarifier to reduce the organic load in biological reactor (aeration basin). About 40% of organic load is intercepted in primary clarifier in the form of sludge, decreasing the loading in the aeration tank. Detention period in aeration tank is maintained between 4-6 h. After aeration tank, the mixed liquor is sent to secondary clarification where sludge and liquid are separated. A major portion of the sludge is re-circulated and excess sludge is sent to a digester.

Sludge generated in primary clarifier and excess sludge from secondary clarifier are not matured, digestion of such sludge is essential before disposal. In anaerobic sludge digestion, such sludge produces biogas which can be used for power generation by gas engines. Generated power can be used for operation of plant.

Merits

- Good process flexibility
- Reliable operation
- Proven track record in all plant sizes
- Less land requirements
- Low odor emission
- Energy production
- Ability to withstand nominal changes in water characteristics

Demerits

- High energy consumption
- Skilled operators needed
- Uninterrupted power supply is required
- Requires sludge digestion and drying
- Less nutrient removal

Exhibit 2: MBBR - Moving Bed Biofilm Reactor

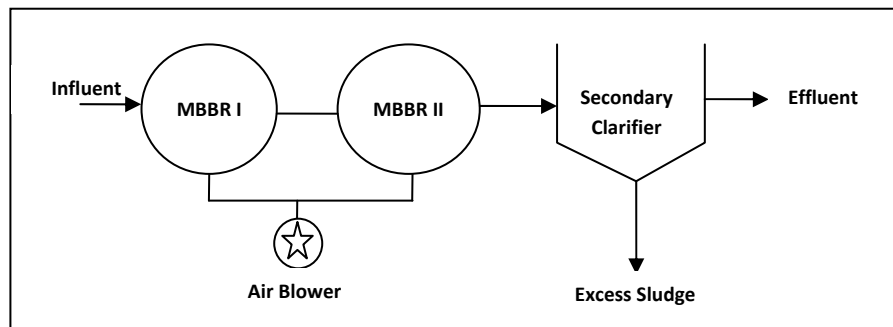

Schematic Diagram of a Moving Bed Bio-Reactor

Moving Bed Biofilm Reactor is an aerobic attached biological growth process. It does not require primary clarifier and sludge recirculation. Raw sewage, after screening and de-gritting, is fed to the biological reactor. In the reactor, floating plastic media is provided which remains in suspension. Biological mass is generated on the surface of the media. Attached biological mass consumes organic matter for their metabolism. Excess biological mass leaves the surface of media and it is settled in clarifier. Usually a detention time of 5 to 12 h is provided in the reactors.

MBBR were initially used for small sewage flow rates and because of less space requirement. In large plant, media quantity is very high and it requires long shut down period for plant maintenance. In fact, it may not be successful for large capacity plants. Moreover the plastic media is patented and not available in the open market, leading to single supplier conditions which limit or deny price competition. In addition, due to very less detention time and other engineering factors, functional Moving Bed Biofilm Reactor in India do not produce acceptable quality effluent.

Merits

- Moving Bed Biofilm Reactor needs less space since there is no primary clarifier and detention period in reactor is generally 4-5 h.
- Ability to withstand shock load with equalization tank option
- High operator oversight is not required

Demerits

- High operating cost due to large power requirements
- Not much experience available with larger capacity plants (>1.5 MLD)
- Skilled operators needed
- No energy production
- Effluent quality not up to the mark in India
- Much less nutrient removal
- Designed criteria not well established

Exhibit 4: UASB+ASP - Upflow Anaerobic Sludge Blanket Followed by Activated Sludge Process

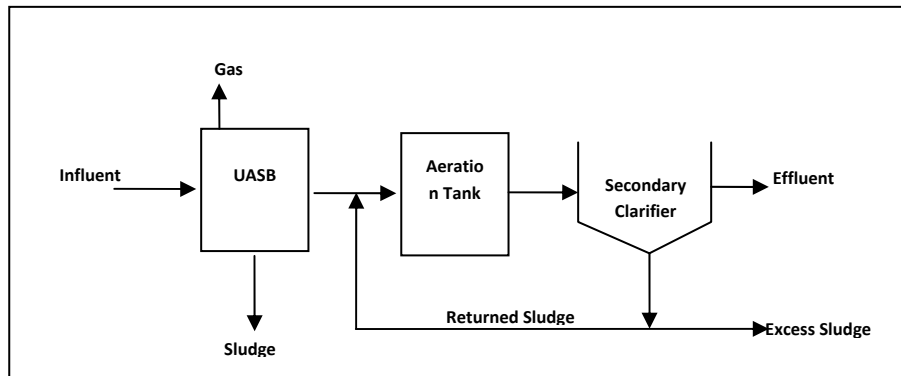

Schematic Diagram of an Upflow Anaerobic Sludge Blanket Process followed by ASP

It is an anaerobic process in which influent wastewater is distributed at the bottom of the UASB reactor and travels in an up-flow mode through the sludge blanket. Critical components of UASB design are the influent distribution system, the gas-liquid-solid separator (GLSS) and effluent withdrawal design. Compared to other anaerobic processes, UASB allows the use of high hydraulic loading.

Merits

- Relatively simple operation and maintenance
- No external energy requirement and hence less vulnerable to power cuts
- No primary treatment required
- Energy production possible but generally not achieved
- Low sludge production
- No special care or seeding required after interrupted operations
- Can absorb hydraulic and organic shock loading

Demerits

- Post treatment required to meet the effluent standard
- Anoxic effluent exerts high oxygen demand
- Large Land requirement
- More man-power require for O&M
- Effluent quality is not up to the mark and poor fecal and total coliform removal
- Foul smell and corrosion problems around STP area
- High chlorine dosing required for disinfection.
- Less nutrient removal

Exhibit 5: MBR - Membrane Bioreactor

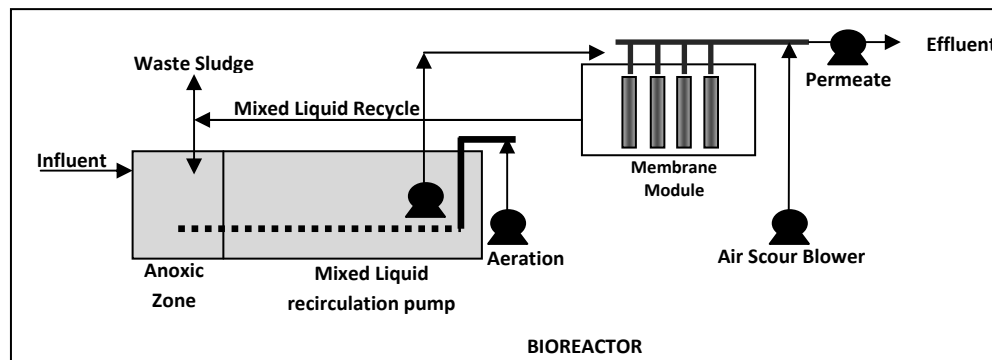

Schematic Diagram of a Membrane Bioreactor

It is a biological reactor with a suspended biomass. The solid-liquid separation in membrane bioreactor is achieved by a microfiltration membrane with pore sizes ranging from 0.1 to 0.4 μm . No secondary clarifier is used and has the ability to operate at high MLSS concentrations. Membranes are patented and not available in the open market, leading to single supplier conditions which limit or deny price competition.

Merits

- Low hydraulic retention time and hence low foot print (area) requirement
- Less sludge production
- High quality effluent in terms of low turbidity, TSS, BOD and bacteria
- Stabilized sludge
- Ability to absorb shock loads

Demerits

- High construction cost
- Very high operation cost
- Periodic cleaning and replacement of membranes
- High membrane cost
- High automation
- Fouling of membrane
- No energy production

Exhibit 6: WSP - Waste Stabilization Pond (Combination of Anaerobic and Aerobic Pond)

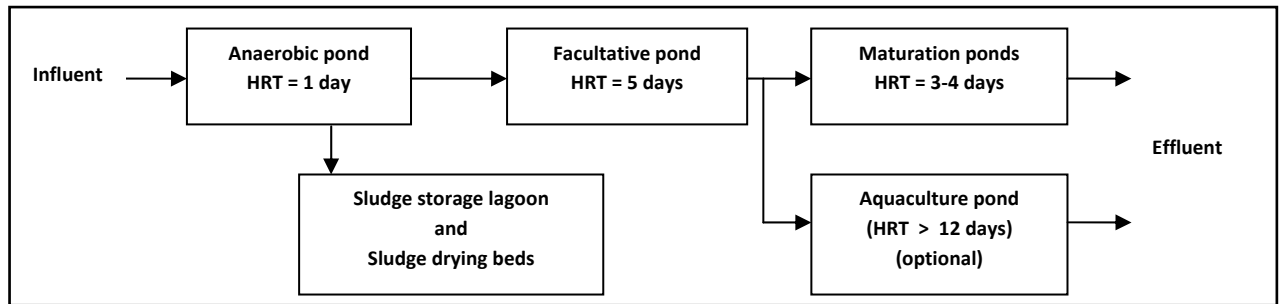

Schematic Diagram of a Waste Stabilization Pond

Sewage is treated in a series of earthen ponds. Initially after screening and de-gritting it is fed to an anaerobic pond for initial pretreatment; depth of anaerobic pond is usually 3 to 3.5 m; as a result the lower section of pond does not get oxygen and an anaerobic condition is developed. BOD reduction takes place by anaerobic metabolism and gases like ammonia and hydrogen sulphide are produced creating odor problems. After reduction of BOD by 40% it enters the facultative/aerobic pond, which is normally 1 - 1.5 m in depth. Lesser depth allows continuous oxygen diffusion from atmosphere; in addition algae in the pond also produces oxygen.

Though BOD at the outlet remains within the range, sometimes the effluent has green color due to presence of algae. The algae growth can contribute to the deterioration of effluent quality (higher total suspended solids) from time to time. Moreover, coliforms removal is also in 1-2 log order. The operating cost of a waste stabilization pond is minimum, mostly related to the cost of cleaning the pond once in two to three years. A waste stabilization pond requires a very large land area and it is normally used for small capacity plant, especially where barren land is available.

Merits

- Simple to construct and operate and maintain
- Low operating and maintenance cost
- Self sufficiency, ecological balance, and economic viability is greater
- Possible recovery of the complete resources
- Good ability to withstand hydraulic and organic load fluctuations

Demerits

- Requires extremely large areas
- Large evaporation loss of water
- If liner is breached, groundwater is impacted
- Effluent quality may vary with seasons
- No energy production
- Comparatively inferior quality of effluent
- Less nutrient removal
- High chlorine dosing for disinfection
- Odor and vector nuisance
- Loss of valuable greenhouse gases to the atmosphere

Exhibit 7: CW - Constructed Wetlands

Wetlands are natural processes similar to stabilization ponds. Wetlands are shallow ponds comprising of submerged plants and floating islands of marshy species. Natural forces including chemical, physical, biological and solar is involved in the process to achieve wastewater treatment. Thick mats of vegetation trap suspend solids and biological process takes place at the roots of the plants. It produces the desired quality of treated sewage but land requirement is very high, though it is less compared to waste stabilization pond. Running cost is comparatively low.

Wetland process have not yet established compared to other processes. There are two types of systems; surface and subsurface distribution of sewage. The type of vegetation grown varies, in some cases there is regular tree cutting and plantation as a part of maintenance work. Plants like Typha, Phragmites, Kattail can be used in India. Another type of wetlands use a plant called duckweed for treatment. This weed has a very fast metabolic rate and absorbs pollutants very quickly.

Merits

- Simple to construct and operate and maintain
- Low operating and maintenance cost
- Self sufficiency, ecological balance, and economic viability is greater
- Possibility of complete resource recovery
- Good ability to withstand hydraulic and organic load fluctuations

Demerits

- Requires large area
- Large evaporation loss of water
- Not easy to recover from massive upset
- If liner is breached, groundwater is impacted
- Effluent quality may vary with seasons
- No energy production
- No nutrient removal
- Odor and vector nuisance
- Loss of valuable greenhouse gases to the atmosphere